



Strengthening the Bank of China

NAME:

CLASS:

DATE:

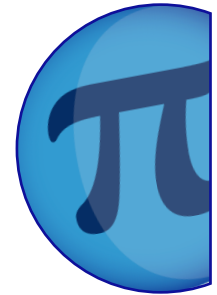

Basic

1) Name the triangles: equilateral, isosceles, scalene or right-angled.

a)

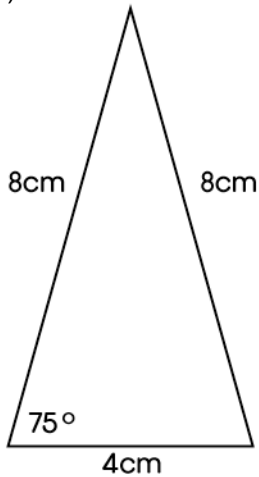

b)

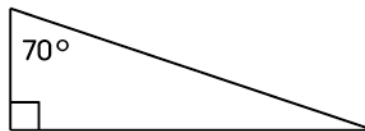

c)

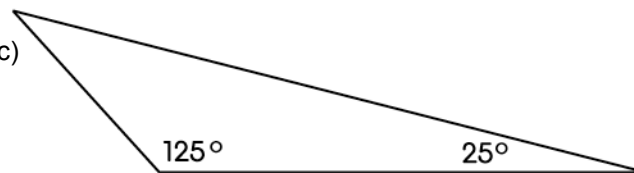

d)

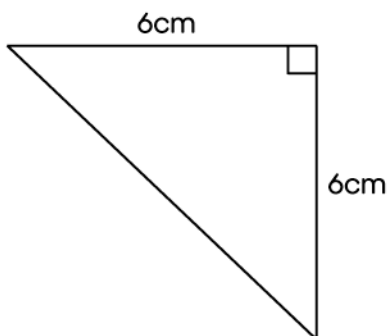

e)

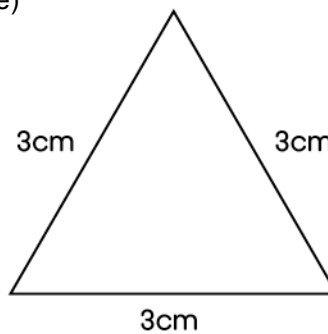

2) In each of the above triangles write in the sizes of all the missing angles.



Strengthening the Bank of China

NAME:

CLASS:

DATE:

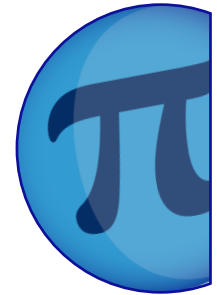

Core

1) In each of the triangles below write in the sizes of all the missing angles.

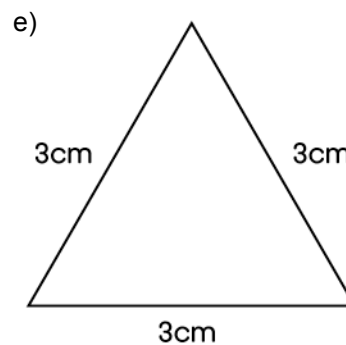
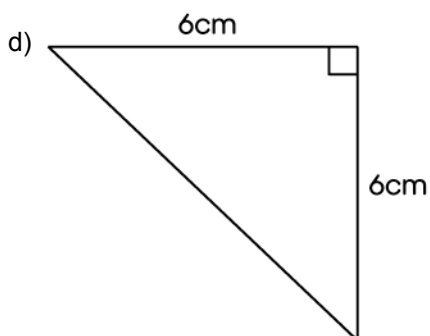
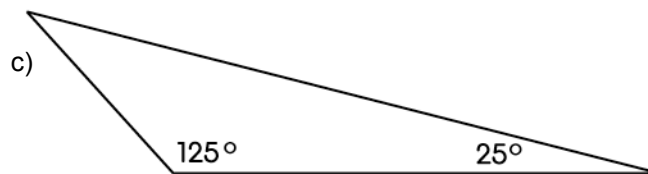
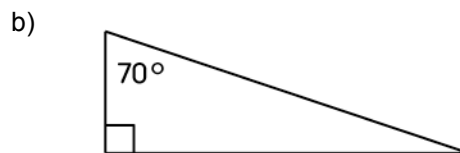
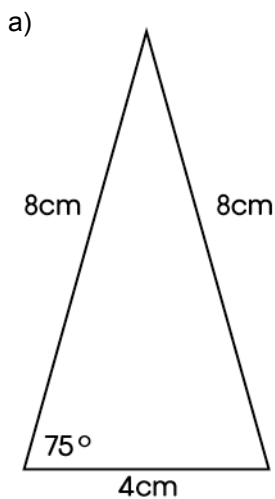

2) In each of the above triangles mark any lines of symmetry that the triangles have.



Strengthening the Bank of China

NAME:

CLASS:

DATE:

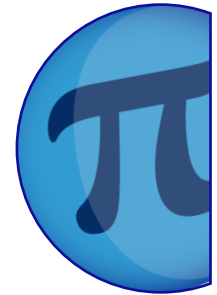

Advanced

1) In each of the triangles below write in the sizes of all the missing angles.

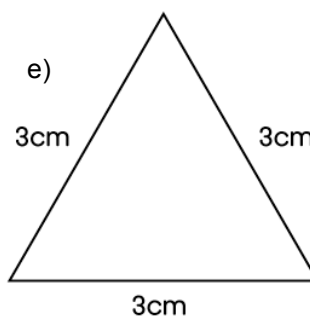
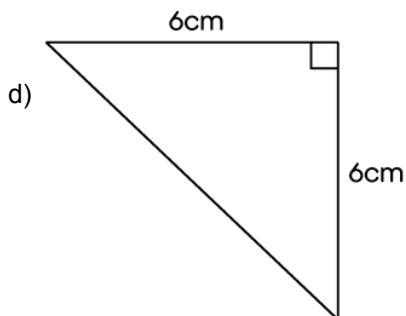
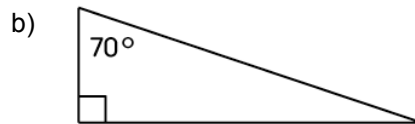
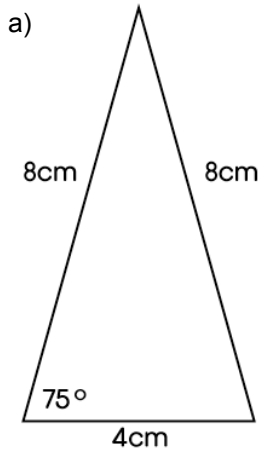

2) Calculate the sum of the interior angles for each of the regular polygons below:

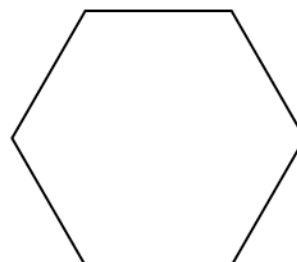
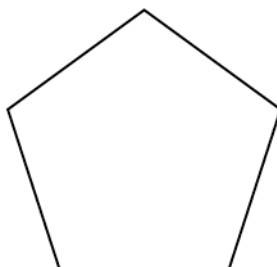
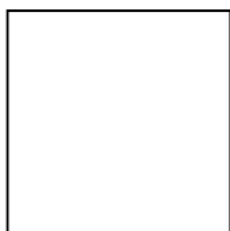



Strengthening the Bank of China

ANSWERS

Basic

1) and 2)

a)

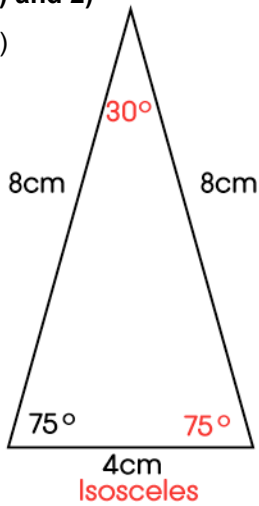

b)

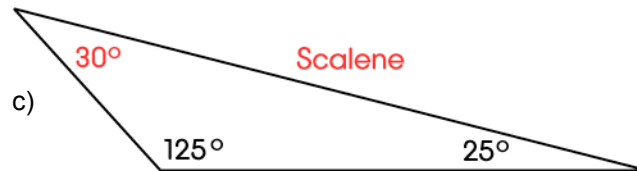
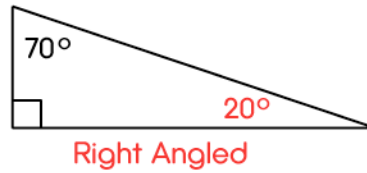

d)

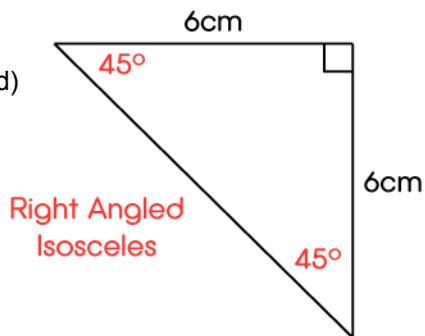

e)

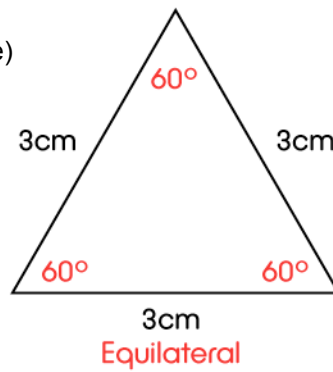



Strengthening the Bank of China

ANSWERS

Core

1) and 2)

a)

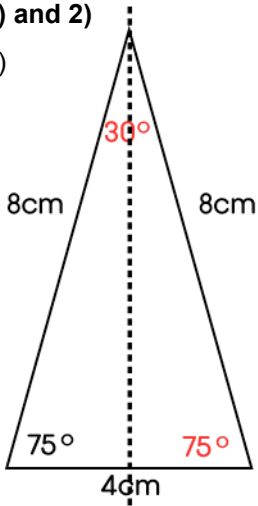

b)

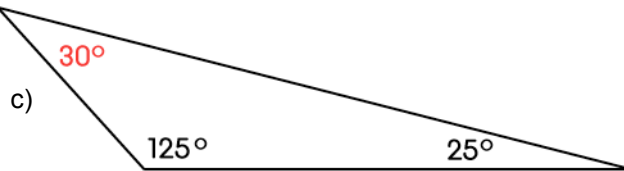

d)

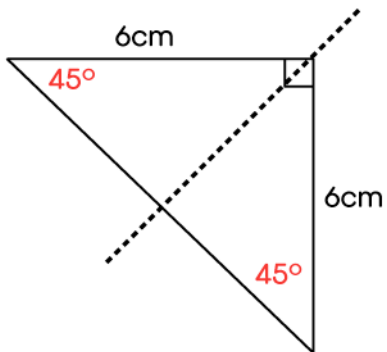

e)

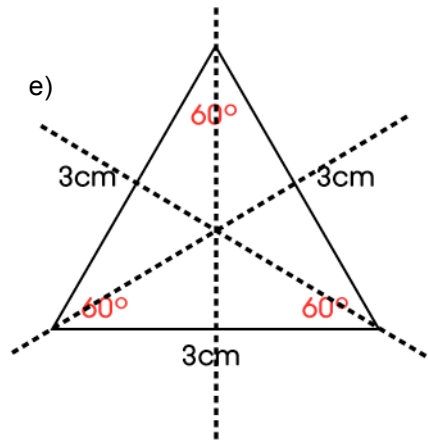



Strengthening the Bank of China

ANSWERS

Advanced

1)

a)

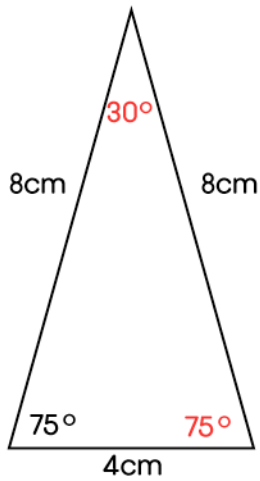

b)

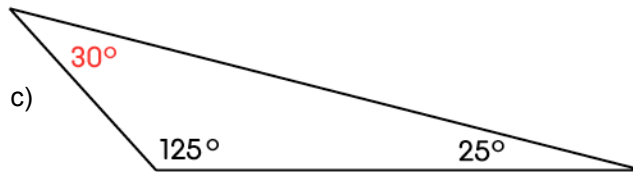

c)

d)

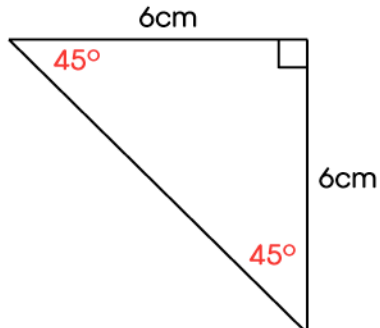

e)

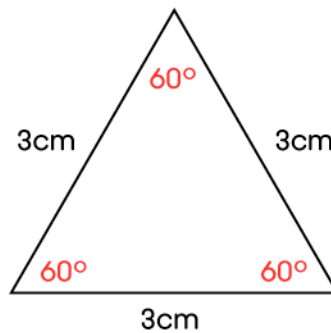

2) a) 360°

b) 540°

c) 720°